

LST02

FDC108/FHDC135/FHDC163 Floor Stand



User manual

TABLE OF CONTENTS

Operational Precautions	4
INTRODUCTION	5
Product Specification	5
Product Overview.....	6
Product View with Display	7
PARTS LIST	8
Parts List.....	8
Tool parts	8
INSTALLATION GUIDE	9
Optoma Global Offices	10

Please read this manual carefully before making any adjustments and retain it for future reference.

Images in the manual are for reference only. If any details in this document are unclear, please contact your local representative for more information.

Operational Precautions

The interior design of Stand has limited dustproof/waterproof capability. Please follow the precautions during installation and use.

INTRODUCTION

Product Specification

Parameter	
Dimensions	2180×825×2031mm
Packaging dimensions (L×W×H)	2290×1170×425mm
Net weight	58kg
Gross weight	93kg
Max load capacity	250kg
Size options of the products that can be loaded	108"/135"/163"
Operating temperature	0°C~40°C
Operating humidity	10%~90%
Storage temperature	-20°C~60°C
Storage humidity	10%~90%

* The package for this model is cartoon and pallet.

INTRODUCTION

Product Overview

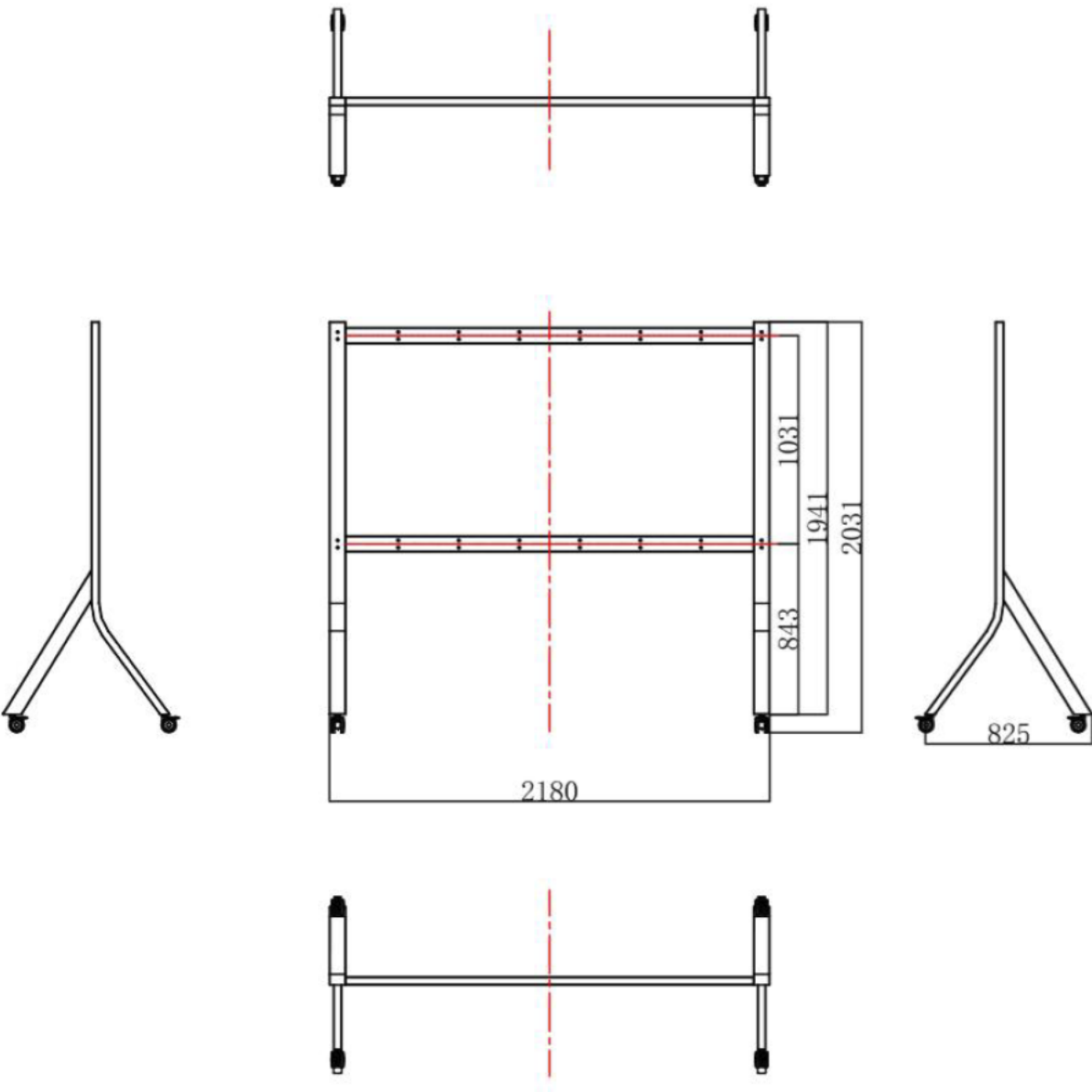

INTRODUCTION



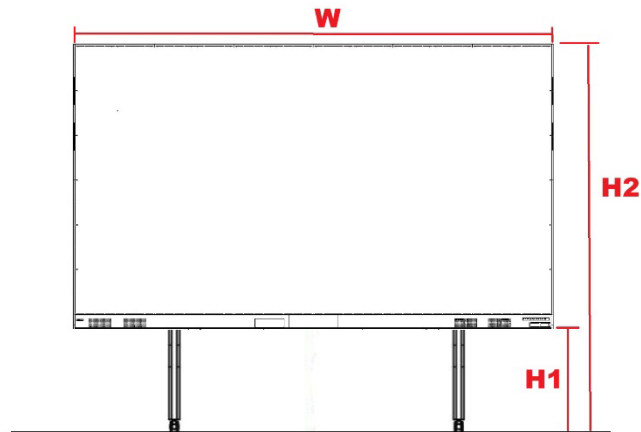

Product View with Display



Model	W	H1	H2
FHDC108	2431 mm	709 mm	2185 mm
FHDC135	3030 mm	709 mm	2523 mm
FHDC163	3630 mm	709 mm	2860 mm

PARTS LIST

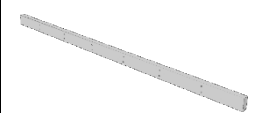
Parts List

No	illustration	Component Name	quantity	note
1		Left-side vertical column	1 PCS	Provides the vertical structure to mount the main beams and provides rollers for the stand .
2		Right-side vertical column	1 PCS	Provides the vertical structure to mount the main beams and provides rollers for the stand .
3		Horizontal bracket	2 PCS	Provides a horizontal structure between the 2 vertical column assemblies and provides an attachment surface for the mount bars..
4		M8x20mm screw	16 PCS	This screw is used to secure the assembly of the floor stand's vertical column and horizontal bracket. This bolt is operated with a 13mm Hex Socket Wrench .

Tool parts

No	image	Part Name	quantity	Remarks
1		13mm Hex Socket Wrench	1 PCS	This tool is used for fastening or removing the nut of the rivet bolt and the M8 screws used in the entire unit..

INSTALLATION GUIDE

INSTALLATION GUIDE

Step 1: Based on the detailed list of floor stand assembly, find the corresponding components, as shown in the figure below : .

Step 2: Tighten the mounting screws with an appropriate tool to complete the installation of the floor stand assembly, as shown in the figure below :

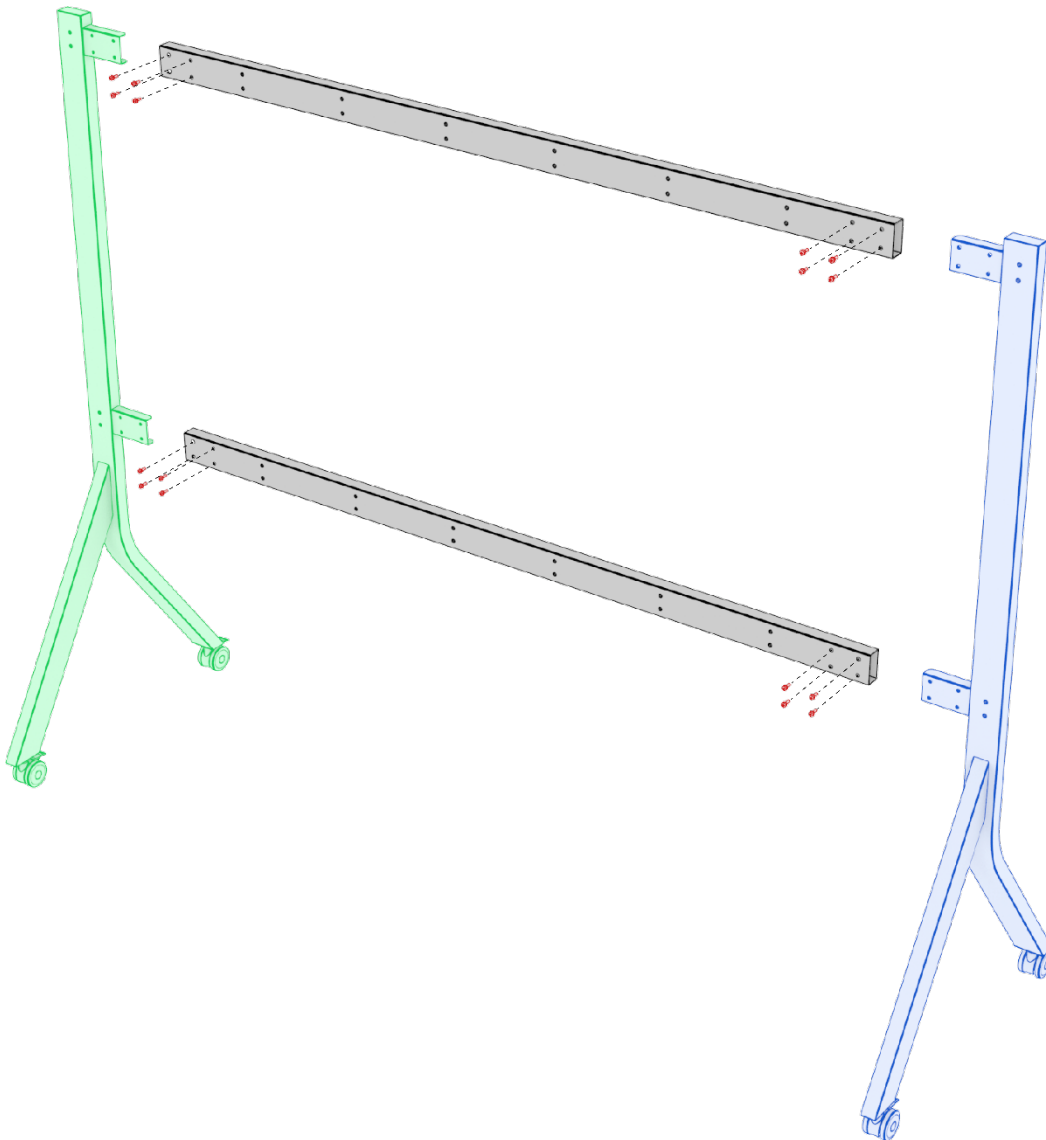





ADDITIONAL INFORMATION

Optoma Global Offices

For service or support, please contact your local office.





USA

Optoma Technology, Inc.
47697 Westinghouse Drive.
Fremont, Ca 94539

 888-289-6786
 510-996-4794
 services@optoma.com





Canada

Optoma Technology, Inc.
47697 Westinghouse Drive.
Fremont, Ca 94539

 888-289-6786
 510-996-4794
 services@optoma.com





Latin America

Optoma Technology, Inc.
47697 Westinghouse Drive.
Fremont, Ca 94539

 888-289-6786
 510-996-4794
 services@optoma.com





Europe

1 Bourne End Mills
Hemel Hempstead
Hertfordshire
HP1 2UJ
United Kingdom
www.optoma.eu
Service Tel : +44 (0)1923 691865

 +44 (0) 1923 691 800
 +44 (0) 1923 691 888
 service@tsc-europe.com





Benelux BV

Optoma Benelux BV
Europalaan 770 D
1363BM Almere
The Netherlands
www.optoma.nl

 +31 (0) 36 8200 250
 +31 (0) 36 548 9052





France

Bâtiment E
81-83 avenue Edouard Vaillant
92100 Boulogne Billancourt, France

 +33 1 41 46 12 20
 +33 1 41 46 94 35
 savoptoma@optoma.fr





Spain

C/ José Hierro, 36 Of. 1C 28529 Rivas
Vaciamadrid, Spain

 +34 91 499 06 06
 +34 91 670 08 32





Deutschland

Optoma Deutschland GmbH
Madriener Straße 10
41069 Mönchengladbach
Deutschland

 +49 (0) 2161 68643 0
 +49 (0) 2161 68643 99
 info@optoma.de

Scandinavia

Hägernähuset
Sjöflygvägen 35
183 62 Täby
Sweden

 +47 32 98 89 90
 +47 32 98 89 99
 info@optoma.no

Korea

<https://www.optoma.com/kr/>

Japan



<https://jp.optoma.com/>

Taiwan

<https://www.optoma.com/tw/>

China

Room 2001, 20F, Building 4,
No.1398 Kaixuan Road,
Changning District
Shanghai, 200052, China

 +86-21-62947376
 +86-21-62947375
www.optoma.com.cn

Australia

<https://www.optoma.com/au/>

